

Chapter 11

Latches and Flip-Flops

SKEE1223 Digital Electronics

Mun'im/Arif/Izam

FKE, Universiti Teknologi Malaysia

December 8, 2015

Types of Logic Circuits

■ **Combinational logic:**

- Output depends solely on the present input.
- Has no memory.

■ **Sequential logic:**

- Output depends not only on the present input and also on past history of inputs.
- Has memory.
- Synchronous sequential logic
 - Use a 'clock' signal to regulate operations.
 - Simpler to design
- Asynchronous sequential logic
 - Does not use a clock.

Types of Memory Elements

- Ungated Latches
- Gated Latches
- Flip-flops

Bistable Circuits

■ Bistable circuit

- Any circuit stable in 0 or 1
- Has memory
- Value does not change by itself
- Simplest bistable circuit : cascaded inverters

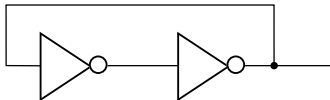

SR Latch

- SR = set/reset
- Replace inverters in prev page with NOR gates
- When $S = R = 0$, operates exactly as cascaded inverters

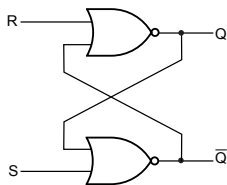
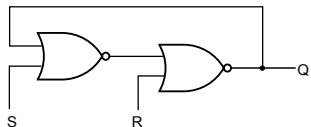

SR Latch

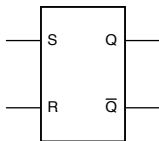

Logic symbol.

S	R	Q(next)	$\overline{Q}(\text{next})$	Action
0	0	Q	\overline{Q}	No change
0	1	0	1	Reset
1	0	1	0	Set
1	1	0	0	Forbidden

Characteristic table.

SR Latch

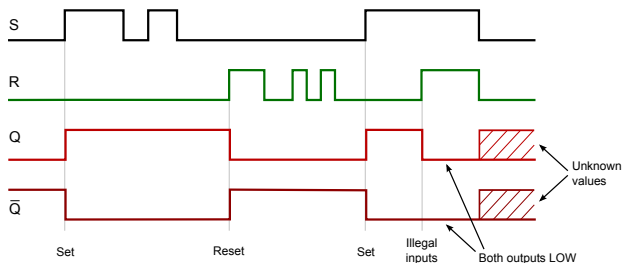

- Q and \bar{Q} are always opposite
- S = R = 0 holds previous value
- S = 1, R = 0 sets Q to 1
- S = 0, R = 1 resets Q to 0
- S = R = 1, both Q and \bar{Q} goes to 0, → forbidden state

$\bar{S}\bar{R}$ Latch

- Same idea as SR latch
- S and R are active low

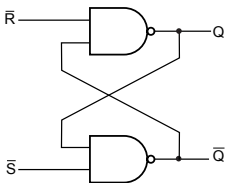

\bar{S}	\bar{R}	Q(next)	$\overline{Q(next)}$	Action
0	0	1	1	Forbidden
0	1	0	1	Set
1	0	1	0	Reset
1	1	Q	\overline{Q}	No change

Gated SR Latch

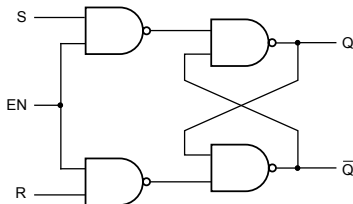
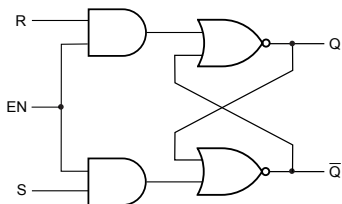

■ EN = 1

- enables latch
- opens **gate** for SR inputs to cross-coupled gates
- works like ungated SR latch

■ EN = 0

- disables latch
- holds prev state
- ignores SR inputs

Gated SR Latch

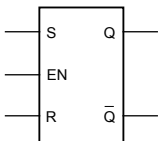

EN	S	R	Q(next)	Action
0	X	X	Q	No change
1	0	0	Q	No change
1	0	1	0	Reset
1	1	0	1	Set
1	1	1	X	Forbidden

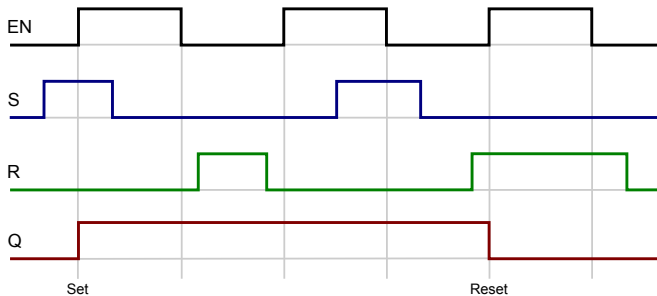

D Latch

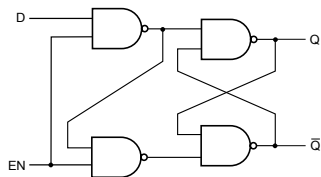
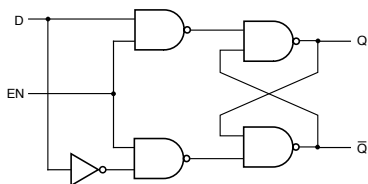

- Modify SR latch to avoid $SR=11$ condition
- $EN = 1$
 - latch become 'transparent'
 - input D is passed to output Q after some delay
- $EN = 0$
 - disables latch
 - ignores D inputs
 - holds last D input when EN went $1 \rightarrow 0$

D Latch

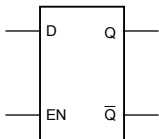

EN	D	Q(next)	Action
0	X	Q	Storage state
1	0	0	Transparent mode
1	1	1	Transparent mode

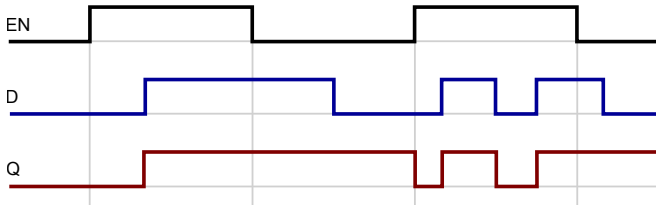

Clock Inputs

- Synchronous digital systems use a clock
- Clock signal is distributed to all system components
- All outputs change simultaneously when a clock pulse arrives

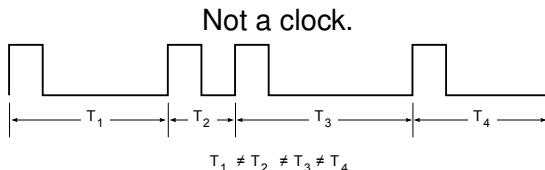
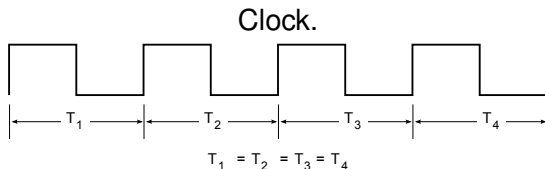

Parts of a Clock Signal

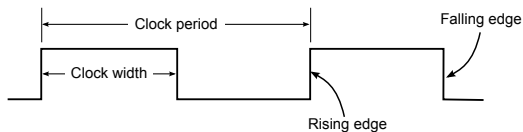

Device	How it uses the clock
Latch	Does not use the clock
Gated latch	Enabled when clock is high
Flip-flop	Triggered by rising or falling clock edge

Master Slave Flip-Flop

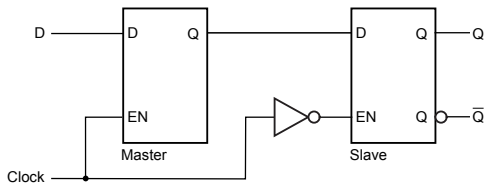

- Clock high
 - Master enabled, slave disabled
 - Input D is transparently passed on to Q_{master}
- Clock low
 - Master disabled, slave enabled
 - Q_{master} is locked, and read by slave
 - Q_{slave} is updated

D Flip-Flop

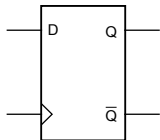

Clk	D	Q(next)	Action
0	X	Q	No change
1	X	Q	No change
↑	0	0	Reset
↑	1	1	Set

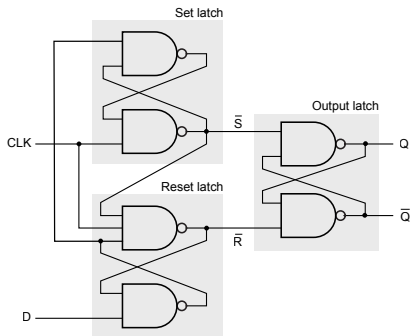

D Flip-Flop

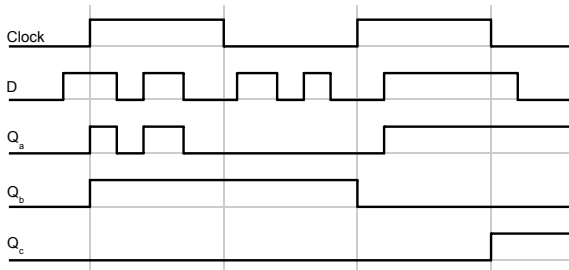
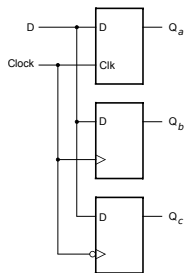

T Flip-Flop

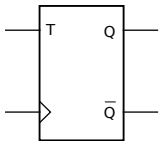

Clk	T	Q(next)	Action
0	X	Q	No change
1	X	Q	No change
↑	0	Q	Hold
↑	1	\bar{Q}	Toggle

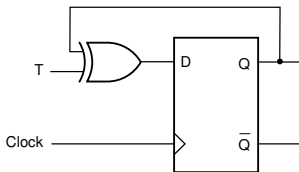

JK Flip-Flop

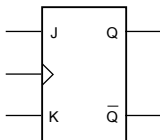

C	S	R	Q(next)	Action
0	X	X	Q	No change
1	X	X	Q	No change
↑	0	0	Q	No change
↑	0	1	0	Reset
↑	1	0	1	Set
↑	1	1	X	Toggle

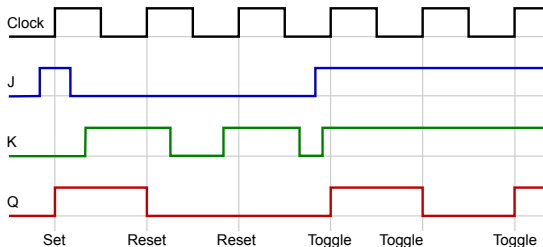

JK Flip-Flop

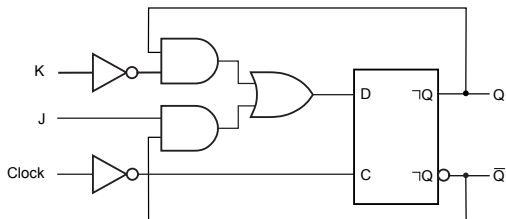
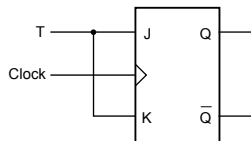
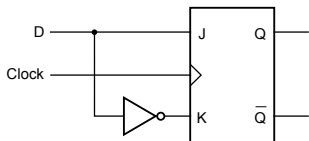

Flip-Flop Timing

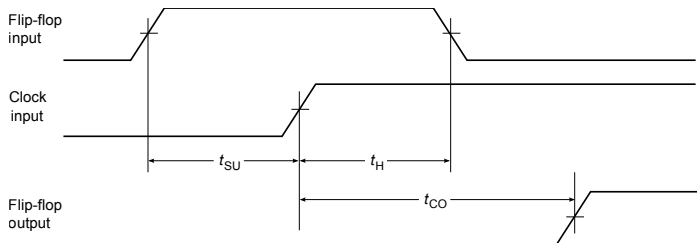

- t_s – Setup time
 - The time a control input must be maintained before the clock transition.
- t_h – Hold time
 - The time a control input must be maintained after the clock transition.
- t_{PCQ} – Propagation delay from clock to output change
 - The time a flip-flop changes after a clock edge is given

74x74 D PET FF

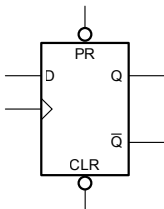

Preset	Clear	D	Clock	Q(next)
1	1	0	↑	0
1	1	1	↑	1
1	1	x	0	Q
1	1	x	1	Q
0	1	x	x	1
1	0	x	x	0
0	0	x	x	NA

74x76 Master Slave JK FF

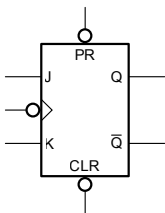

Preset	Clear	J	K	Clock	Q(next)
1	1	0	0	↑	Q
1	1	0	1	↑	0
1	1	1	0	↑	1
1	1	1	1	↑	\bar{Q}
1	1	x	x	0,1	Q
0	1	x	x	x	1
1	0	x	x	x	0
0	0	x	x	x	NA



<https://www.openlearning.com/courses/SKEE1223x>