

Chapter 3

Logic Implementations

SKEE2263 Digital Systems

Mun'im Zabidi {munim@utm.my}
Ismahani Ismail {ismahani@fke.utm.my}
Izam Kamisian {e-izam@utm.my}

Faculty of Electrical Engineering, Universiti Teknologi Malaysia

February 10, 2018

Taxonomy of Logic Devices

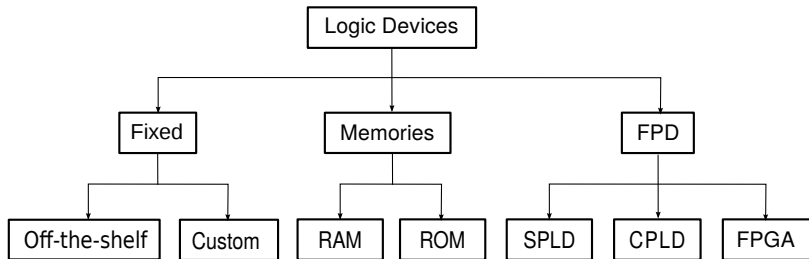

Logic Devices

Fixed – Functions defined during manufacture.

- 1 Off-the-shelf – designer can order from a catalog
- 2 Custom – designed for one customer, made by semiconductor foundry

Memory – Holds big amounts of data. Separate fabrication to get highest density

- 1 RAM – random access memory
- 2 ROM – read-only memory

Logic Devices

FPD – Field-Programmable Devices. Blank devices that must be configured/programmed before use. Also called Programmable Logic Devices (PLD)

- 1** SPLD – Simple PLD. A few hundred gates.
- 2** CPLD – Complex PLD. A few thousand gates. Fundamental technology same as SPLD.
- 3** FPGA – Field-Programmable Gate Array. A few million gates.

2:1 mux

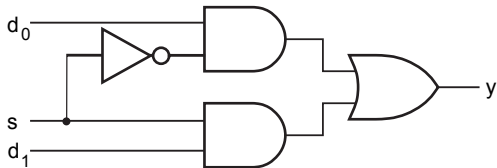

$$y = s'd_0 + sd_1$$

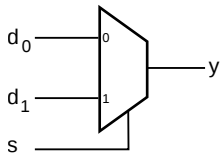

Distinctive symbol

4:1 mux

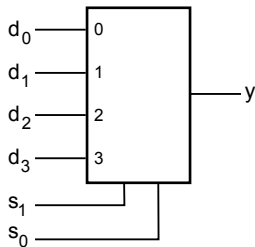

$$y = s'_1 s'_0 d_0 + s'_1 s_0 d_1 + s_1 s'_0 d_2 + s_1 s_0 d_3$$

Word Multiplexer

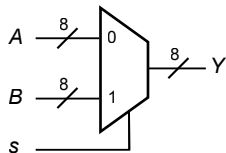
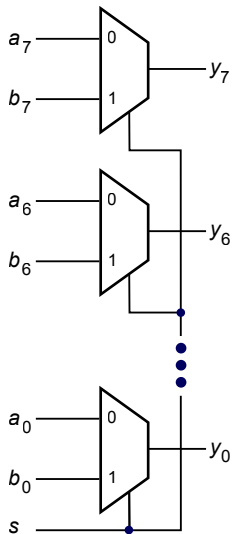

Mux Implementation of Logic Functions #1

Direct input

a	b	c	f
0	0	0	0
0	0	1	1
0	1	0	0
0	1	1	0
1	0	0	1
1	0	1	1
1	1	0	1
1	1	1	0

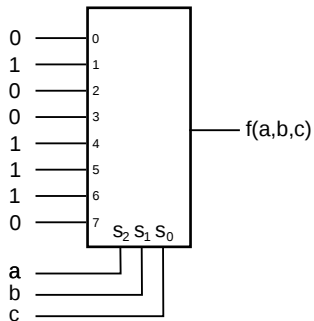

Mux Implementation of Logic Functions #2

a	b	c	f
0	0	0	0
0	0	1	1
0	1	0	0
0	1	1	0
1	0	0	1
1	0	1	1
1	1	0	1
1	1	1	0

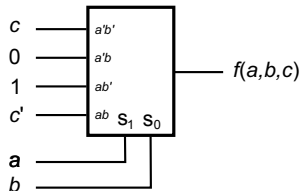

Mux Implementation of Logic Functions #3

<i>a</i>	<i>b</i>	<i>c</i>	<i>d</i>	<i>f</i>
0	0	0	0	0
0	0	0	1	0
0	0	1	0	1
0	0	1	1	1
0	1	0	0	1
0	1	0	1	1
0	1	1	0	1
0	1	1	1	1
1	0	0	0	0
1	0	0	1	0
1	0	1	0	0
1	0	1	1	1
1	1	0	0	1
1	1	0	1	0
1	1	1	0	1
1	1	1	1	1

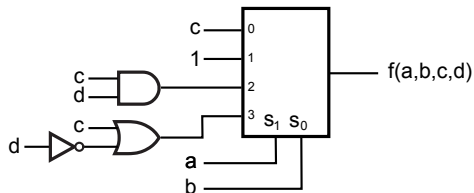

Mux Implementation of Logic Functions #4

K-map

select variables

a ← data variable
 bc ↓

	0	1
00	0	0
01	1	0
11	1	1
10	0	1



bc	
00	0
01	a'
11	1
10	a

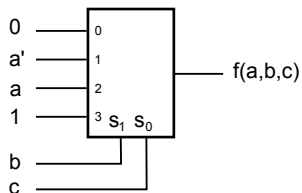

Mux Implementation of Logic Functions #5

Algebraic Manipulation

$$\begin{aligned}f(a, b, c) &= ab' + b'c + ac' \\ &= ab'(c + c') + b'c(a + a') + ac'(b + b') \\ &= ab'c + ab'c' + ab'c + a'b'c + abc' + ab'c' \\ &= a'b'c + ab'c + ab'c' + abc' \\ &= a'b'c + ab'(c + c') + abc' \\ &= a'b'(c) + a'b(0) + ab'(1) + ab(c')\end{aligned}$$

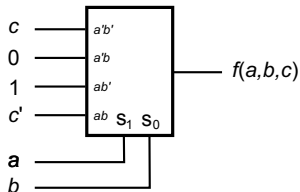

Mux Implementation of Logic Functions #6

Variable Substitution

The output function of the 2-to-1 multiplexer is $y = s'd_0 + sd_1$

The expression $f(a, b, c) = a'c + ab$ fits the mux equation pattern.

$$\begin{array}{ccccccccc} f & = & a' & c & + & a & b & & \\ \downarrow & & \downarrow & \downarrow & & \downarrow & \downarrow & & \\ y & = & s' & d_0 & + & s & d_1 & & \end{array}$$

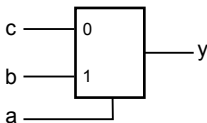

Mux Implementation of Logic Functions #7

Implementing Basic Logic Gates

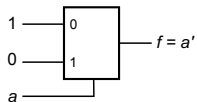

NOT

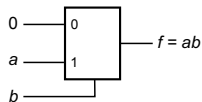

AND

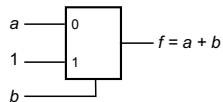

OR

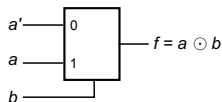

XNOR

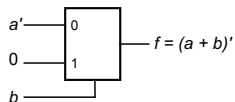

NOR

Decoders

$$s(x, y, z) = \sum m(1, 2, 4, 7)$$

$$c(x, y, z) = \sum m(3, 5, 6, 7)$$

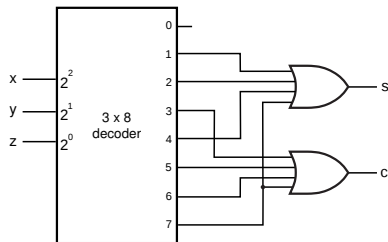

Buffer Truth Table

A	B
0	0
1	1

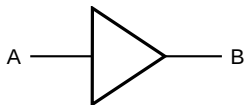

Buffer Application

Using buffer to increase current

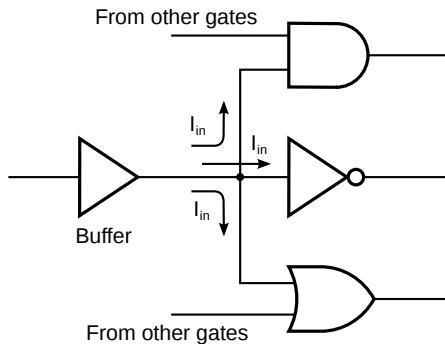

Tristate Buffer Truth Table

A	EN	B
0	1	0
1	1	1
×	0	Z

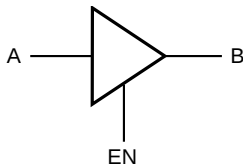

Tristate Buffer Equivalent Circuit

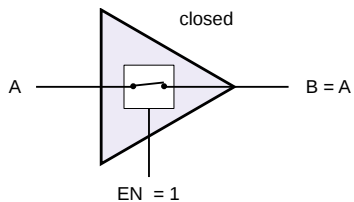
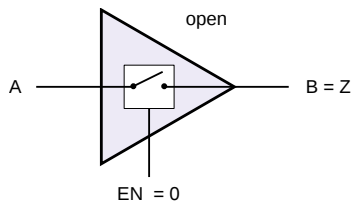

Memory Taxonomy

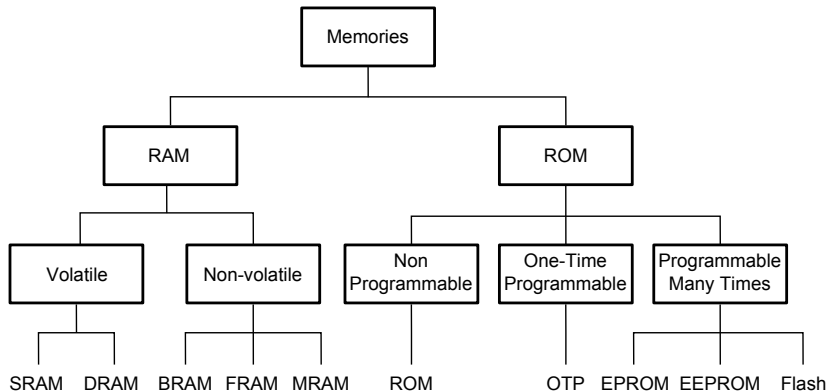

Simplified Memory Model

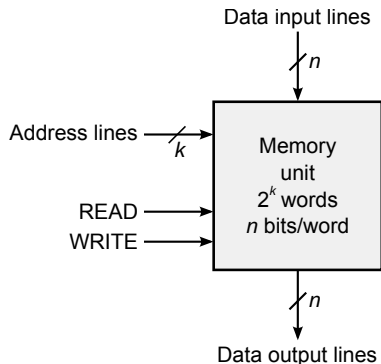

Terms:

- **Organization**
 $= 2^k \times n$
- **#locations (a.k.a. entry, row or "word")**
 $= 2^k$
- **index is called "address"**
- **#bits/location**
 $=$ word size
 $= n$

ROM-based Lookup Table (LUT)

Inputs			Outputs						Decimal
P2	P1	P0	Q5	Q4	Q3	Q2	Q1	Q0	
0	0	0	0	0	0	0	0	0	0
0	0	1	0	0	0	0	0	1	1
0	1	0	0	0	0	1	0	0	4
0	1	1	0	0	1	0	0	1	9
1	0	0	0	1	0	0	0	0	16
1	0	1	0	1	1	0	0	1	25
1	1	0	1	0	0	1	0	0	36
1	1	1	1	1	0	0	0	1	49

ROM-Based Squarer

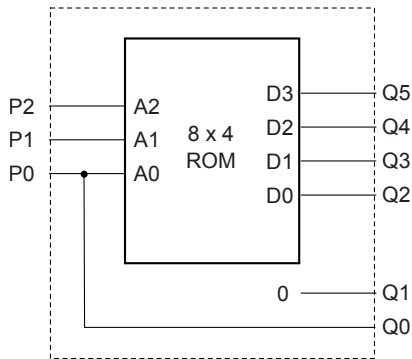

Squarer ROM Contents

Input			Output			
A2	A1	A0	D3	D2	D1	D0
0	0	0	0	0	0	0
0	0	1	0	0	0	0
0	1	0	0	0	0	1
0	1	1	0	0	1	0
1	0	0	0	1	0	0
1	0	1	0	1	1	0
1	1	0	1	0	0	1
1	1	1	1	1	0	0

Squarer ROM Programming

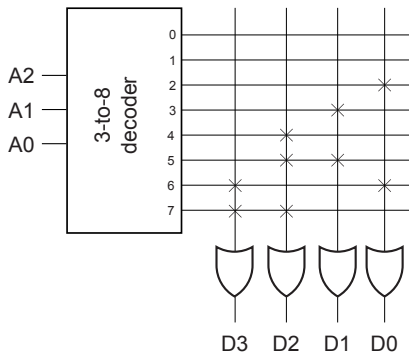

Basic Architecture of FPGA

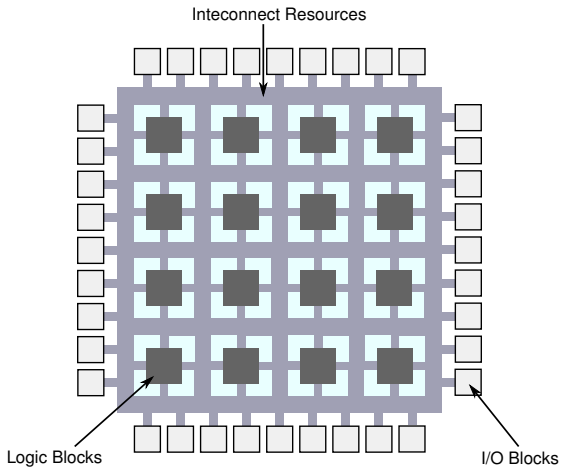

Basic Architecture of Logic Blocks

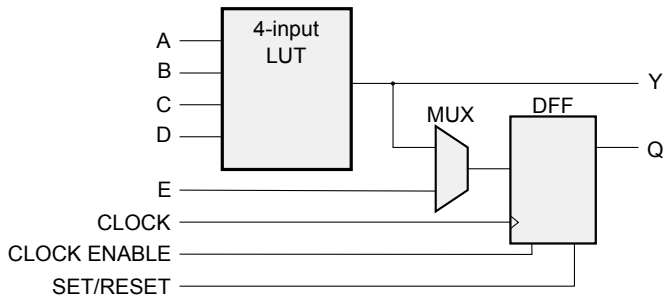

LB Lookup Tables

They are just muxes

Required function

$$y = a \mid (b \& c)$$

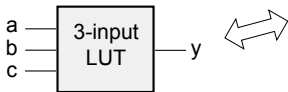
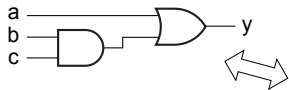

Truth table

a	b	c	y
0	0	0	0
0	0	1	0
0	1	0	0
0	1	1	1
1	0	0	1
1	0	1	1
1	1	0	1
1	1	1	1

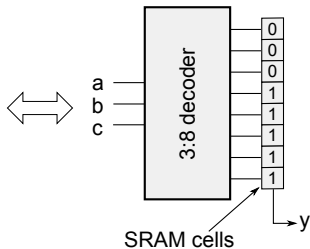

CPLD/FPGA Design Flow

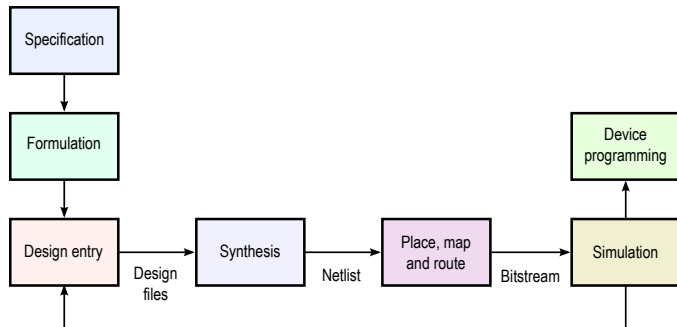

Quartus handles both Altera CPLD and FPGA

- Simple designs → use schematic capture
- Complex designs → use hardware design language (HDL) e.g. VHDL or Verilog